

LED Signal Tower Light



※ Silver color available

		LED Signal Tower Light			
Type		AUT-L	AUT-LF	AUTN-L	AUTN-LF
Bulb	Steady	•		•	
	Flashing		•		•
Voltage		AC110V ~ AC220V DC12V / DC24V		AC110V ~ AC220V DC12V / DC24V	
Material		Lens - GPPS Body - ABS / Reflector - PC		Lens - Optical expansion PC Body - ABS / Reflector - PC	
Output		Power type / Contact type		Power type / Contact type	
Layers		1 - 5 layers		1 - 5 layers	
Dimensions (mm)	Outdia	Ø58		Ø58	
	Height	410 mm ~ 576 mm (mounted on SH20)		410 mm ~ 576 mm (mounted on SH20)	
	Depth	-		-	
Buzzer volume		Max. 85 dB		Max. 85 dB	
Color change by layer		Available		Available	
Mounting method		Horizontal(SH20,SH08,SH04)/Vertical(SV20,SV06)/Direct connection(G)/Direct vertical(DV)/Adjustable Angle(AP20,AP06)			
Customization		Buzzer / Melody / Pole length selection / Horizontal type + Magnet attachment			
Page		p.46	p.46	p.47	p.47

Ethernet / Device Net / USB LED / Connector / Ø40 Signal Design Tower Light



		Ethernet	Device Net	USB	Connector	LED Ø40
Type		AUT-EN	AUT-DN	AUT-U	AUT-CO	AUT-40
Bulb	Steady		•	•	•	•
	Flashing	•		•		•
Voltage		AC110V~220V/DC24V	DC24V	DC5V	DC12V ~ 24V	DC24V
Material		Lens - GPPS Body - ABS / Reflector - PC	Lens - GPPS Body - ABS / Reflector - PC	Lens - GPPS Body - ABS / Reflector - PC	Lens - GPPS Body - ABS / Reflector - PC	Lens - PC Body - PC
Layers		1~4 layers	1~5 layers	1~5 layers	1~5 layers	3,5 layers
Dimensions (mm)	Outdia	Ø58	Ø58	Ø58	Ø58	Ø40
	Height	410mm ~ 534,5mm*	210,5mm ~ 376,5mm*	410mm ~ 576mm*	305mm ~ 467mm*	270mm / 330mm*
	Depth	-	-	-	-	-
Buzzer volume		Max. 85dB	Max. 90dB	Max. 85dB	Max. 90dB	Max. 90dB
Color change by layer		Available	Available	Available	Available	Unavailable
Mounting method		Horizontal (SH20,SH08,SH04) Vertical (SV20,SV06) Direct (G) / Direct vertical (DV) Adjustable Angle (AP20,AP06)	Exclusive bracket	Horizontal (SH20,SH08,SH04) Vertical (SV20,SV06) Direct (G) / Direct vertical (DV) Adjustable Angle (AP20,AP06)	Vertical (SV06)	Exclusive bracket Direct (G)
Timbre		1 buzzer, 3 siren sounds	Buzzer	Buzzer	Buzzer	Buzzer
Page		p.49	p.50	p.51	p.52	p.53

* SH20 Standard type



AUT - L / LF Series

LED Steady / Flashing Signal Tower Light



AUT- L / AUT- LF



External volume adjustment

- LED Steady / Flashing type Signal Tower Light
- Excellent radiant effect achieved using special vacuum metallizing reflector together with high luminance LED
- Operators can change color of each layer
- Color combinations other than standard
- Built-in 8 melodies and notification sounds (basic 4 notes)
- Volume can be adjusted from the outside (Max. 85dB)
- Mounting pole (length, type) are selectable (default SH20)
- Magnet mounted type is available for horizontal pole (SH)
- External diameter : Ø58
- Material : Lens [GPPS], Body [ABS], Reflector [PC], Pole [Al]
- Operating Temperature : -25 ~ 50°C (freezing free)
- ※ Default wire length : 1m
- ※ Use contact-type products when extending more than 10m cable



AUT-L / LF

LED Steady/Flashing Signal Tower Light

Type	L	Voltage	Current		Weight	Color	
			LED	Audible Options			
AUT-L Steady type	1	AC110~220	12.5mA	15mA (AC)	348g (AC)	● Red(R)	
		DC12V DC24V	40mA 50mA		312g (DC)		
	2	AC110~220	25mA		385g (AC)	● Red(R) ● Green(G)	
		DC12V DC24V	80mA 100mA		349g (DC)		
	3	AC110~220	37mA		210mA (DC12V)	422g (AC)	● Red(R) ● Yellow(Y) ● Green(G)
		DC12V DC24V	110mA 135mA			386g (DC)	
	4	AC110~220	49mA		170mA (DC24V)	459g (AC)	● Red(R) ● Yellow(Y) ● Green(G) ● Blue(B)
		DC12V DC24V	140mA 170mA			423g (DC)	
	5	AC110~220	61mA		170mA (DC24V)	496g (AC)	● Red(R) ● Yellow(Y) ● Green(G) ● Blue(B) ○ White(W)
		DC12V DC24V	170mA 205mA			460g (DC)	
AUT-LF Flashing type	1	AC110~220	13mA	15mA (AC)	388g (AC)	● Red(R)	
		DC12V DC24V	65mA 65mA		332g (DC)		
	2	AC110~220	26mA		425g (AC)	● Red(R) ● Green(G)	
		DC12V DC24V	130mA 130mA		369g (DC)		
	3	AC110~220	38.5mA		210mA (DC12V)	462g (AC)	● Red(R) ● Yellow(Y) ● Green(G)
		DC12V DC24V	180mA 185mA			406g (DC)	
	4	AC110~220	51mA		170mA (DC24V)	499g (AC)	● Red(R) ● Yellow(Y) ● Green(G) ● Blue(B)
		DC12V DC24V	230mA 240mA			443g (DC)	
	5	AC110~220	63.5mA		170mA (DC24V)	536g (AC)	● Red(R) ● Yellow(Y) ● Green(G) ● Blue(B) ○ White(W)
		DC12V DC24V	280mA 295mA			480g (DC)	

User Order Specifications

Warning sound	Audible Options	CH	Tone
AM Melody	4 sounds	1	Fur Elise
		2	Home Sweet Home
		3	The Magic Flute
		4	Piano Sonatas
AA Alarm	4 sounds	1	Beep ~ beep ~ beep
		2	Ding Dong
		3	Beep-ee
		4	Beep beep beep beep



AUTN - L / LF Series

LED Steady / Flashing Signal Tower Light



AUTN-L / AUTN-LF



Using PC Light Diffusion Lens

Product Features

- Using PC light diffusion lenses, light is subtle and luxurious.
- User Order Specifications Same as AUT-L / LF Series.

- LED Steady / Flashing type Signal Tower Light
- Excellent radiant effect achieved using special vacuum metallizing
- Operators can change color of each layer
- Apart from the standard buzzer, 8 different melodies can be installed
- For melody / Alarm type, different sounds can be applied to each of up to 4 layers
- Volume can be adjusted from the outside (Max. 85dB)
- Mounting pole (length, type) are selectable (default SH20)
- External diameter : Ø58
- Material : Lens [GPPS], Body [ABS], Reflector [PC], Pole [Al]
- Operating Temperature : -25 ~ 50°C (freezing free)
- Default wire length : 1m
- Use contact-type products when extending more than 10m cable



AUTN-L/LF

LED Steady/Flashing White Signal Tower Light

Type	L	Voltage	Current		Weight	Color	
			LED	Audible Options			
AUTN-L	1	AC110~220	12.5mA	15mA (AC)	348g (AC)	● Red(R)	
		DC12V DC24V	40mA 50mA		312g (DC)		
	2	AC110~220	25mA	210mA (DC12V)	385g (AC)	● Red(R) ● Green(G)	
		DC12V DC24V	80mA 100mA		349g (DC)		
	3	AC110~220	37mA	170mA (DC24V)	422g (AC)	● Red(R) ● Yellow(Y) ● Green(G)	
		DC12V DC24V	110mA 135mA		386g (DC)		
	4	AC110~220	49mA	15mA (AC)	459g (AC)	● Red(R) ● Yellow(Y) ● Green(G) ● Blue(B)	
		DC12V DC24V	140mA 170mA		423g (DC)		
	5	AC110~220	61mA	15mA (AC)	496g (AC)	● Red(R) ● Yellow(Y) ● Green(G) ● Blue(B) ○ White(W)	
		DC12V DC24V	170mA 205mA		460g (DC)		
	AUTN-LF	1	AC110~220	13mA	15mA (AC)	388g (AC)	● Red(R)
			DC12V DC24V	65mA 65mA		332g (DC)	
2		AC110~220	26mA	210mA (DC12V)	425g (AC)	● Red(R) ● Green(G)	
		DC12V DC24V	130mA 130mA		369g (DC)		
3		AC110~220	38.5mA	170mA (DC24V)	462g (AC)	● Red(R) ● Yellow(Y) ● Green(G)	
		DC12V DC24V	180mA 185mA		406g (DC)		
4		AC110~220	51mA	15mA (AC)	499g (AC)	● Red(R) ● Yellow(Y) ● Green(G) ● Blue(B)	
		DC12V DC24V	230mA 240mA		443g (DC)		
5		AC110~220	63.5mA	15mA (AC)	536g (AC)	● Red(R) ● Yellow(Y) ● Green(G) ● Blue(B) ○ White(W)	
		DC12V DC24V	280mA 295mA		480g (DC)		



Nomenclature

①	②	③	④	⑤	⑥
Series	Type	Layers	Audible Option	Voltage	Mounting accessories
AUT	L : Steady type	1 : 1 layer 2 : 2 layer	No mark : None AM : Melody	110/220 : AC110V ~ 220V 12 : DC12V	SH20 : Horizontal 200mm SH08 : Horizontal 80mm SH04 : Horizontal 40mm SV20 : Vertical 200mm SV06 : Vertical 60mm G : Direct connection DV : Direct vertical AP20 : Adjustable Angle 200mm AP06 : Adjustable Angle 60mm
AUTN	LF : Flashing type	3 : 3 layer 4 : 4 layer 5 : 5 layer	AA : Alarm	24 : DC24V	

Technical Diagram & Wiring Instructions

Technical Diagram
[Unit : mm]

Power type (AC/DC)

Contact type (AC/DC)

Power type AC/DC (M : Melody / A : Alarm)

Contact type AC/DC (M : Melody / A : Alarm)

Mounting accessories

Horizontal SH	Vertical SV	Direct connection G	Direct vertical DV	Adjustable Angle AP



AUT- EN Series

- A Signal Tower controlled by connecting internet or LAN
- Control with computer web browser or applications
- Can be used for remote control
- Separate utility provided to set IP address, subnet mask, and gateway
- Maximum 4 layers of LED flashing type
- 4 basic sounds (1 buzzer, 3 siren sounds) are provided
- Selectable mounting pole (length, type) (default SH20)
- Magnet mount available when horizontal pole (SH) is ordered as a user additional option
- Outdia : Ø58 / Default LAN length : 3m / Max. 85dB
- Material : Lens [GPPS], Body [ABS], Reflector [PC], Pole [Al]
- Operating Temperature : -25 ~ 50°C (freezing free)

Technical Diagram

[Unit : mm]

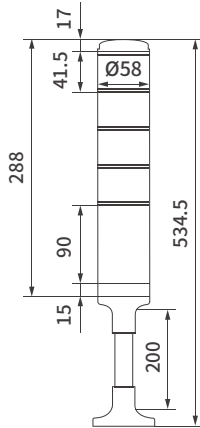

AUT-EN

Ø58 Ethernet Signal Tower Light

Type	Layers	Voltage	Weight	Audible Options	Color
AUT-EN Ether Net	1	AC110~220V	505g	1 buzzer sounds alarm	Red(R)
		DC24V	414g		Red(R) Green(G)
	2	AC110~220V	542g	3 siren sounds Urgent Emergency	Red(R) Yellow(Y) Green(G)
		DC24V	451g		Red(R) Yellow(Y) Green(G) Blue(B)
	3	AC110~220V	579g	Fire	Red(R) Yellow(Y) Green(G)
		DC24V	488g		Red(R) Yellow(Y) Green(G) Blue(B)
	4	AC110~220V	616g		Red(R) Yellow(Y) Green(G)
		DC24V	525g		Red(R) Yellow(Y) Green(G) Blue(B)

How to Use & Connecting Diagram

Setup tool

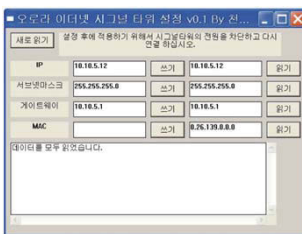

- It sets IPs, subnet masks, and gateways for signal towers.

Webpage screen for testing

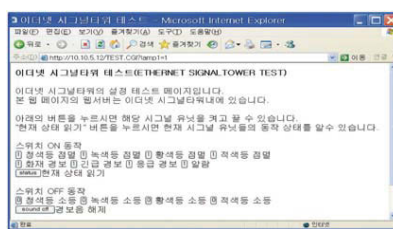

- A Signal Tower contains web server and web page, and the operation can be tested with web browser.

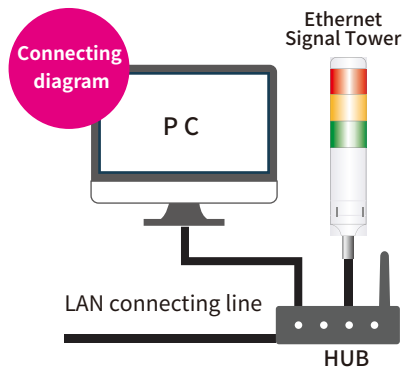

Nomenclature

AUT - EN

①

Layers

②

Audible Option

③

Voltage

④

Mounting accessories

**Ethernet
Signal Tower Light**

- 1 : 1 Layer
- 2 : 2 Layers
- 3 : 3 Layers
- 4 : 4 Layers

- No mark : None
- AM : Melody
- AA : Alarm

- 110/220 : AC110V ~ 220V
- 24 : DC24V

- SH20 : Horizontal 200mm
- SH08 : Horizontal 80mm
- SH04 : Horizontal 40mm
- SV20 : Vertical 200mm
- SV06 : Vertical 60mm
- G : Direct connection
- DV : Direct vertical
- AP20 : Adjustable Angle 200mm
- AP06 : Adjustable Angle 60mm



AUT - DN Series

Ø58 Device Net Signal Tower Light



AUT-DN Series

- Signal Tower Light only for Device Net
- Direct connection to network without separated I/O terminal for device net
- Convenient to install and easy to maintain due to the smaller installation space and reduced wires
- Controlled by PLC device net master
- Set the address (MAC ID) and communication speed with built in DIP switch
- Supports all communication speeds (125kbps, 250kbps, 500kbps) in device net, and also supports automatic speed setting for convenient use
- External diameter : Ø58 / Max. 90dB
- Material : Lens [GPPS], Body [ABS], Reflector [PC]
- Operating Temperature : -25 ~ 50°C (freezing free)



AUT- DN

Ø58 Device Net Signal Tower Light

Technical Diagram

[Unit : mm]

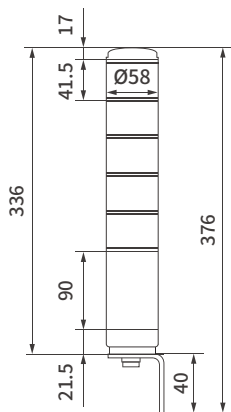

Type	Layers	Voltage	Height	Weight	Color
AUT-DN	1	DC24V	210.5mm	368g	● Red(R)
	2		252mm	405g	● Red(R) ● Green(G)
	3		293.5mm	442g	● Red(R) ● Yellow(Y) ● Green(G)
	4		335mm	479g	● Red(R) ● Green(G) ● Yellow(Y) ● Blue(B)
	5		376.5mm	516g	● Red(R) ● Blue(B) ● Yellow(Y) ● White(W) ● Green(G)

Features

- Built-in buzzer, Steady type and DC24V by default
- Color moving by layer is possible
- Buzzer function provided in addition to up to 5 colors of LED unit per Signal Tower.
- Mount using the exclusive bracket

Nomenclature

AUT - DN -
Device Net
Signal Tower Light

①
Layers

① Layers

- 1 : 1 Layer
- 2 : 2 Layers
- 3 : 3 Layers
- 4 : 4 Layers
- 5 : 5 Layers

? What is Device Net?

- Device net is a field bus for easy access among control devices such as PLC, PC, sensor, and actuator. Saves wiring cost, reduces the potential for wiring errors, is easy to maintain, and can be used for real-time control. It is CAN-based and strong on noise. As it allows mutual access among devices from different vendors, it enables more economical system establishment. Can remove a connected device from the network without stopping the whole network. An open style field that is used for a wide range of purposes.

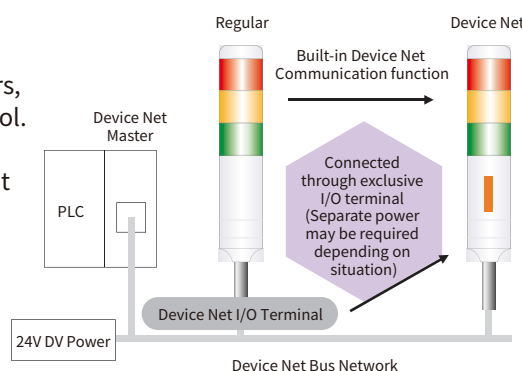

Advantages of Device Net Signal tower

- Direct connection to network with built-in device net communication function (power line and signal line are integrated into single cable)
 - Saved space
 - Reduced wiring
- Convenient installation & maintenance



AUT- U Series

- Signal Tower connected to USB port and controlled by programs on PC
- All signals and power are supplied together through a single USB cable (voltage DC5V)
- Can be used on a host that support USB 1.1 or higher
- Can be utilized for a range of purposes as a regular PC accessory
- Basic buzzer is embedded along with up to 5 layers and 5 colors of LED unit per a Signal Tower depending on the model
- Selectable mounting pole (length, type) (default SH20)
- Magnet mounted type is available with the optional horizontal pole (SH)
- External diameter : Ø58 / Default LAN length : 3m / Max. 85dB
- Material : Lens [GPPS], Body [ABS], Reflector [PC], Pole [Al]
- Operating Temperature : -25 ~ 50°C (freezing free)



AUT- U

USB Signal Tower Light

Technical Diagram

[Unit : mm]

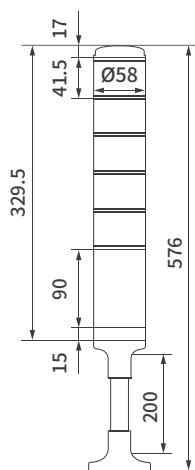

Type	Layers	Voltage	Height	Weight	Color
AUT-U	1	DC5V	410mm	380g	● Red(R)
	2		451.5mm	419g	● Red(R) ● Green(G)
	3		493mm	458g	● Red(R) ● Yellow(Y) ● Green(G)
	4		534.5mm	497g	● Red(R) ● Green(G) ● Yellow(Y) ● Blue(B)
	5		576mm	536g	● Red(R) ● Blue(B) ● Yellow(Y) ○ White(W) ● Green(G)

Use

- To inform of computer process status
- To provide warning signals to many people at a long distance without passing through a monitor
- For any warning message displayed on a computer

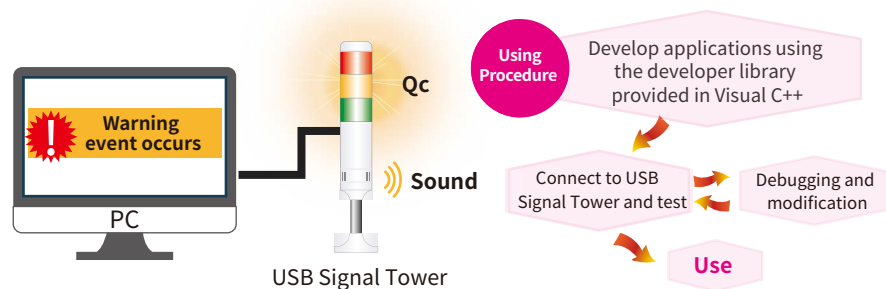

Nomenclature

AUT - U

①

Layers

②

Mounting accessories

USB Signal Tower Light

- 1 : 1 Layer
- 2 : 2 Layers
- 3 : 3 Layers
- 4 : 4 Layers
- 5 : 5 Layers

SH20 : Horizontal 200mm SV06 : Vertical 60mm

SH08 : Horizontal 80mm

G : Direct connection

SH04 : Horizontal 40mm

DV : Direct vertical

SV20 : Vertical 200mm

AP20 : Adjustable Angle 200mm

AP06 : Adjustable Angle 60mm



AUT - CO Series

Connector Type Signal Tower Light



AUT- CO Series

- Connector Type Signal Tower Light
- 1 basic sounds (buzzer) are provided
- DC voltage models , available from DC12 to 24V
- Maximum 5 layers of LED Steady type
- Mounting accessories SV06 pole Available exclusively
- External diameter : Ø58 / Max. 90dB
- Cable : M12 4PIN Cable (Male) / Cable length : 350mm
- The number of Cable : 1L: 1EA / 2L: 2EA / 3L: 2EA / 4L: 3EA / 5L: 3EA
- Material : Lens [GPPS], Body [ABS], Reflector [PC], Pole [Al]
- Operating Temperature : -25 ~ 50°C (freezing free)



Mount using the SV06 pole only



M12 4PIN Cable (Male)



AUT- CO

Connector Type Signal Tower Light

TYPE	Layer	Voltage	LED Current	Buzzer Current	Height	Weight	Color
AUT-CO	1	DC 12V ~ DC 24V	77 mA	37 mA	305 mm	390 g	(1L) ● Red (R)
	2		143 mA		348 mm	469 g	(1L) ● Red (R) (2L) ● Green (G)
	3		220 mA		381 mm	504 g	(1L) ● Red (R) (2L) ● Yellow (Y) (3L) ● Green (G)
	4		296 mA		424 mm	582g	(1L) ● Red (R) (3L) ● Green (G) (2L) ● Yellow (Y) (4L) ● Blue (B)
	5		352 mA		467 mm	622 g	(1L) ● Red (R) (4L) ● Blue (B) (2L) ● Yellow (Y) (5L) ○ White (W) (3L) ● Green (G)

Product Specifications

- Built-in buzzer & Steady type by default
- Voltage DC12 ~ 24V Only
- Buzzer function provided in addition to up to 5 colors of LED unit per Signal Tower
- Mount using the SV06 pole only
- With M12 PIN Cable

Nomenclature

AUT - CO -



Layers

Connector Type
Signal Tower Light

- 1 : 1 Layer
- 2 : 2 Layer
- 3 : 3 Layer
- 4 : 4 Layer
- 5 : 5 Layer



AUT - 40L / LF Series

Ø40 LED Steady / Flashing Signal Design Tower Light



AUT- 40 Series

- LED Steady / Flashing signal tower Light
- High brightness LEDs are placed in all four directions and transparent PC cover is used for excellent divergence
- This can be wired with transistor(PNP Type), so it can be used in PLC, etc
- 5 body color options (Black, Yellow, Ivory, Orange and Silver)
- Wiring cable withdrawal type, individual color cannot be changed
- External diameter : Ø40 / Max. 90dB
- Installation bolt : 4mm, Direct connection
- Material : Lens [PC], Body [PC]
- Operating temperature : -25 ~ 50°C (freezing free)



AUT- 40

Type	Layer	Voltage	Height	Weight	Color
AUT-40-3	3	DC24V	260mm	195 g	(1 Layer) ● Red (2 Layer) ● Yellow (3 Layer) ● Green
AUT-40-5	5		330mm	230 g	(1 Layer) ● Red (4 Layer) ● Blue (2 Layer) ● Yellow (5 Layer) ○ White (3 Layer) ● Green

Technical Diagram & Wiring Instructions

Technical Diagram [Unit: mm]		Steady / Flashing / Alarm
<p>3 Laers</p>	<p>5 Laers</p>	

Nomenclature

AUT - 40 -

①

Type

②

Layers

③

Audible Option

④

Voltage

Ø40
Signal Design Tower Light

L : Steady type
LF : Flashing type

3 : 3 Layers
5 : 5 Layers

AA : Alarm

24 : DC24V



70ST5 Series

Multi-Color LED Square Signal Tower Light



- An economic model that transmits five color signals to the first stage of the square tower light
- High-brightness LED light source for excellent visibility in dark places
- Aluminum square profile makes the appearance beautiful
- Color and buzzer indicating the condition or danger of the machine
- LED color : Red , Yellow , Green, Blue, White
- Rated voltage : AC110~220V / DC24V
- Power consumption : 16W
- Indicating operation : Steady / Flashing
- Sound : buzzer sound < intermittent or continuous sound / volume 1m Max. 90dB at 1m
- Material : Body [Al] / Bracket [ABS] / Lens [PC] / Pole [Al]
- Operating Temperature : -20 ~ 70°C (freezing free)
- *Nut Type Size : 70 X 70 X 332(mm)



SG-70ST5

Size (W X L X H)	Mounting Size	Mounting hole
70mm X 70mm X 283mm	60.8mm X 60.8mm	Ø 4.5

Technical Diagram & Wiring Instructions

Technical Diagram	AC Wiring Instructions	DC Wiring Instructions
<p>[Unit : mm]</p>		

※ No DC polarity

Nomenclature

SG - **70** **ST** **5** - **220A** **OF**

① ② ③ ④ ⑤

- | | | | | |
|----------------|----------------|-------------------------|---------------------|------------------------------|
| ① Product size | ② Product name | ③ LED color | ④ Voltage | ⑤ Type |
| 70 X 70mm | Signal Tower | 5 Color (R, Y, G, B, W) | AC110~220V
DC24V | ON : Steady
OF : Flashing |





- ⊙ Semicircular wall attachment with small protrusions to minimize damage with slim protrusions
- ⊙ Clear color with internal transparent lens and external colored diffusion lens
- ⊙ IP55 structure allows outdoor use
- ⊙ Installation of buzzer holes facing down
- ⊙ There are two types of the main body, silver or regular ivory
- ⊙ Two-tone buzzer: long (beep-beep-beep-beep-beep-beep-) / Max. 85dB
- ⊙ Material : Grobe [PC] , Lens [PC] , Body [ABS]
- ⊙ Operating Temperature : -20 ~ 50°C (freezing free)

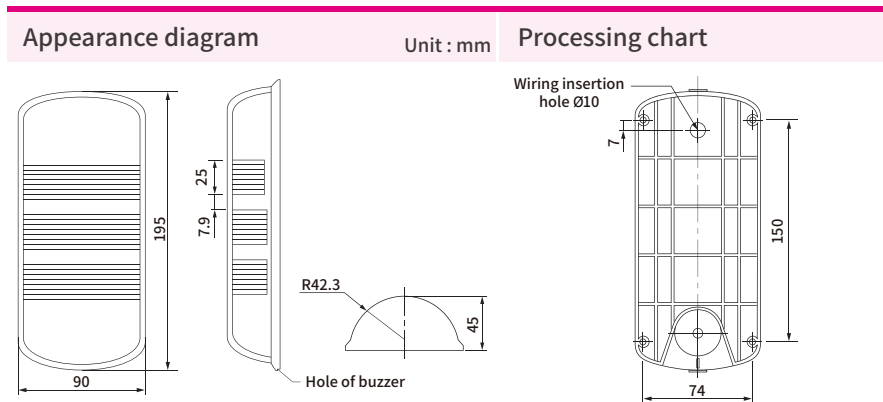

Nomenclature

AUS -	① Series	② Type	③ Layers	④ Audible Option	⑤ Voltage
Semicircular Side Mount LED Signal Tower Light	B : Beige S : Silver	L : Steady type LF : Steady/Flashing type	1 : RYG 2 : 2 layer 3 : 3 layer	No mark : None AB : Buzzer	110/220 : AC110~220V 12/24 : DC12~24V

Wiring Instructions

